

ULTRAHEAT®T450 ULTRACOLD®T450



Technical Description

32 21 000 001 b

Date: 22.09.2021

Landis+Gyr GmbH

Contents

1	General Notes	4
	Other available documentations	4
2	Safety Information	5
3	Technical Data	7
4	Dimensions	8
5	Installation	10
	Changing the installation location	10
	Installation recommendations	11
	Examples of integration	11
	Installation instructions for the adapter set (direct immersion temperature sensor)	12
	Torques	12
	Installation for cooling meters and combined heat/cooling meters	12
	Protection class	13
6	Operating elements	14
6.1	Displaying current meter status	14
	LCD	15
	LOOP 0 "LOOP 0"	16
6.2	Previous year values	17
6.3	Monthly values	17
6.4	Mid-month values	17
7	Display / priority rating	19
8	Power supply	19
	Power supply requirements	20
	Dynamical calculation of battery life	20
9	Communication	21
	Electronic unit interfaces	21
	Terminals	21
9.1	Pulse output module	21
9.2	M-Bus module	22
9.3	Radio Module 868 MHz (Wireless M-Bus)	23
10	Pulse inputs	24
11	Tariff control (optional)	25
	Threshold value tariff (tariff T1 - T5, T9 – T13)	25
	Supplied quantity of energy (tariff T6)	25
	Returned quantity of energy (tariff T6)	26
	Heat / cooling meter (tariff T7)	26
	Surcharge quantity tariff by means of return temperature (tariff T8)	26
	Volume-weighted temperature (Tarif T14)	26
12	Error messages	27
13	Log functions	29
14	Datalogger (optional)	31
15	Order codes (type number key)	33

16	Additional order details	36
16.1	Additional order details for the data logger	36
16.2	Additional order details for the wM-Bus function	36
17	Pressure loss, weight, and dimension of package	38

1 General Notes



Note: In the following text, the term "meter" is used to refer to both the heating meter as well as the cooling meter unless otherwise stated.

















The meter has left the factory in a technically safe condition. Adjustments, maintenance work, replacement of parts or repairs may only be carried out by specialist staff who are aware of the associated hazards. Further technical support is provided by the manufacturer on request. The meter's calibration-relevant security symbols must not be damaged or removed. Otherwise, the warranty and calibration validity of the meter will be invalidated.

Other available documentations

- Operating instructions T450
- Installation instructions T450
- Service instructions T450
- Respective module manual
- List of accessories

Additional information's are available on request.

2 Safety Information

	The meters may only be used in building installations and only for the applications described.
	The local regulations (installation, etc.) must be observed.
	The operating conditions on the nameplate must be observed during use. Failure to comply with these regulations can cause dangerous situations and voids all claims arising from liability for defects as well as liability on the basis of any expressly granted guarantees.
	Comply with the requirements for circulation water (CEN / TR 16911:2016).
	The meter is only suitable for circulation water in heating systems.
	The meter is not suitable for drinking water.
	Do not lift the meter on the calculator.
	Pay attention to sharp edges on threads, flanges and the measuring tube.
	Only personnel trained in the installation and operation of meters in heating/cooling systems may install and remove the meter.
	Only install or remove the meter on an unpressurised system.
	After installing the meter, check the leak tightness of the system.
	Breaking the safety marks relevant for calibration voids the warranty and the validity of the calibration.
	Avoid contact of the meter housing with silicone oils or substances containing silicone oil.
	Only clean the meter from the outside with a soft, slightly moistened cloth. Do not use spirits or cleaning agents.
	The meter must not be energized until it has been fully assembled. Otherwise there is a risk of electric shock on the terminals. A defective or obviously damaged device must be disconnected from the power supply immediately and replaced.
	The meter is valid for disposal as waste electronic equipment within the meaning of the European Directive 2012/19/EU (WEEE) and must not be disposed of as household waste. The corresponding national and legal regulations must be observed

and the device must be disposed of via the channels provided for this purpose. The local and currently valid legislation must be observed.



The meter contains lithium batteries. Do not dispose of the meter and batteries as household waste. Observe local regulations and laws regarding disposal.



After lithium batteries have been used, you can return them to the manufacturer for proper disposal. When shipping batteries please observe legal regulations which among other things govern the labelling and packaging of hazardous goods.



Do not open the batteries. Do not bring batteries into contact with water or expose to temperatures exceeding 80°C.



The meter has no lightning protection. Ensure lightning protection via the house installation.

3 Technical Data

General

Measuring accuracy	Class 2 or 3 (EN 1434)
Mechanical class	M2 (2014/32/EU)
Electromagnetic class	E1 (2014/32/EU)
Ambient humidity	< 93 % rel. humidity at 25 °C, non-condensing
Max. altitude	2000 m above sea level
Storage temperature	-20 ... 60 °C

Calculator

Ambient temperature	5 ... 55 °C
Housing protection rating	IP 54 / IP 68 optional (EN 60529)
Operation threshold f. ΔT	< 0.2 K
Temperature difference ΔT	3 K ... 120 K
Temperature measurement range	0 ... 180 °C
LCD	8-digit
Optical interface	Standard (EN 62056-21)
Communication	Optional, e.g. M-Bus
Separability	Always removable, cable length optional

Temperature sensor

Type	Pt500 or Pt100 (EN 60751)
Temperature range	0 ... 150 °C (up to 45 mm overall length) 0 ... 180 °C (as of 100 mm overall length)

Volume measurement unit

Protection class	IP 54 / IP 65 / IP 68 optional (EN 60529)
Installation site	Hot side / cold side; parameterizable
Installation position	Any
Measuring range	1:100
Temperature range	5 ... 130 °C National approvals may differ.
Recommended for...	
...heating application	10 ... 130 °C
...cooling application	5 ... 50 °C
Maximum overload	2.8 × qp
Nominal pressure	PN16 (PS16), PN25 (PS25)

Power supply

Type of power supply	Battery for 6 - 20 years
Type of battery	AA cell lithium
Lithium content	0.65 g per battery
Number of batteries	1 – 4; depending on configuration

4 Dimensions

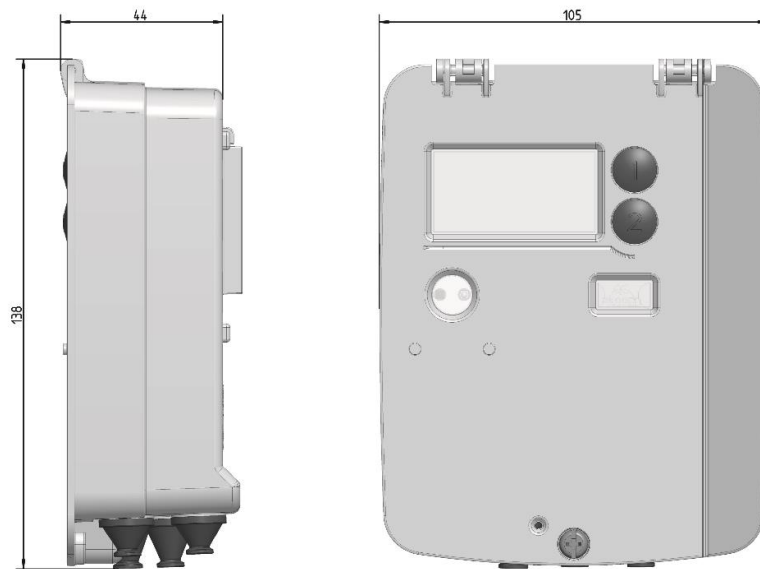

Fig. 1: Dimensions of calculator

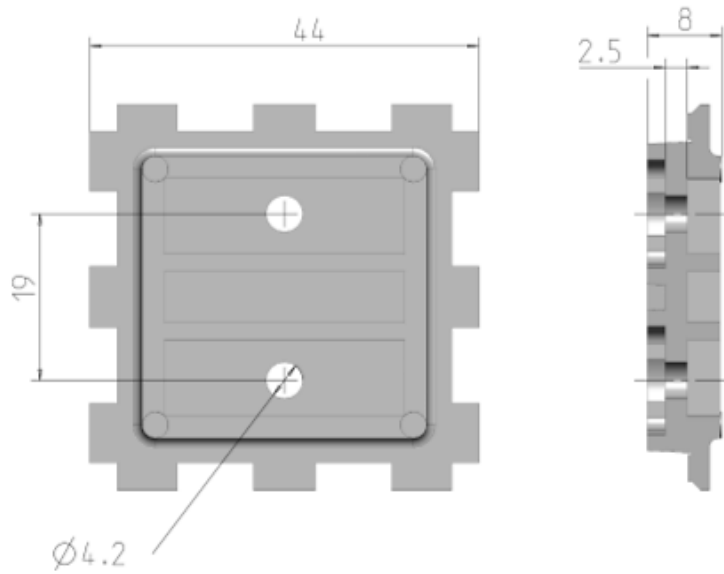

Fig. 2: Plan view and cross-section of adapter plate

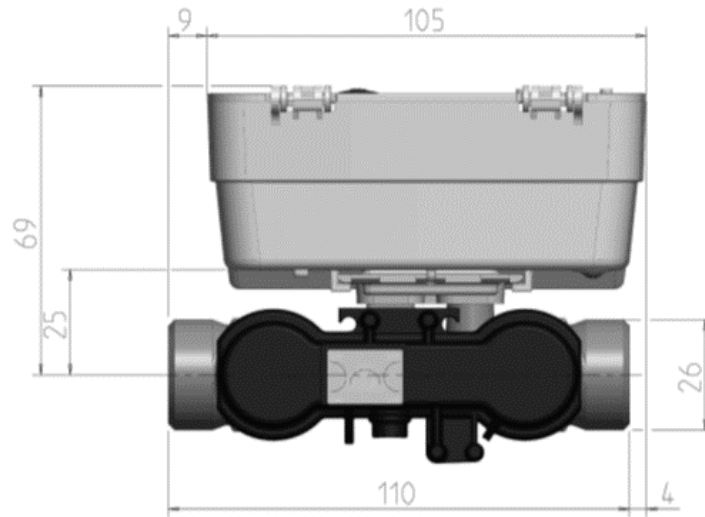

Fig. 3: Overview dimensions overall length 110 mm

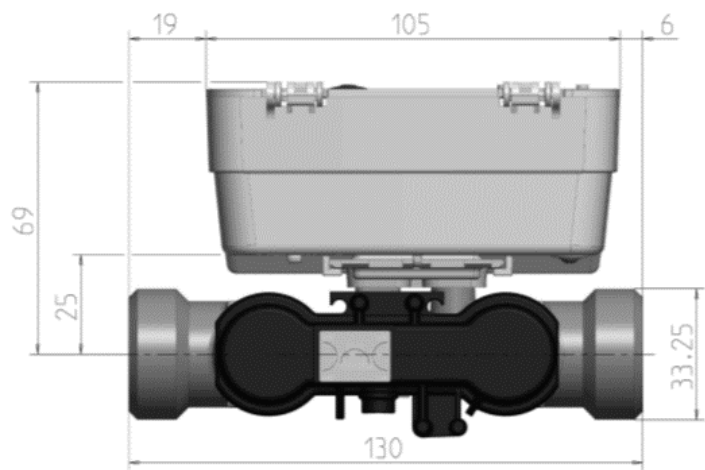

Fig. 4: Overview dimensions overall length 130 mm (thread)

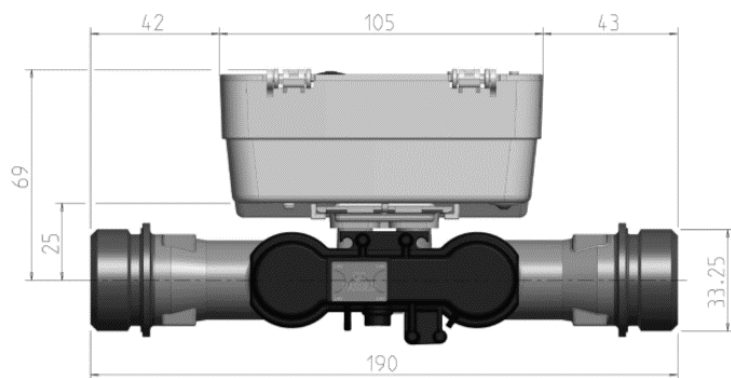

Fig. 5: Overview dimensions overall length 190 mm (thread)

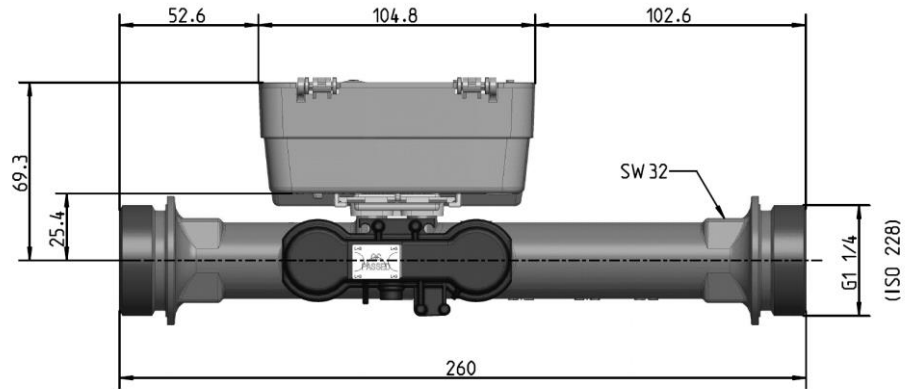

Fig. 6: Overview dimensions overall length 260 mm (thread)

5 Installation

Proceed as follows to install the meter:

- Compare the installation location with the symbol on the LCD (or). If necessary, adjust the installation location of the meter to match the conditions (see chapter “Changing the installation location”).

Note: For a **heat meter** or combined heat / cooling meter, the cold side installation location corresponds to the return and the hot side installation location to the flow .

Note: For a **cooling meter** , the hot side installation location corresponds to the return and the cold side installation location to the flow .

- Note the dimensions of the meter and check whether there is sufficient free space.
- Flush the system thoroughly before installing the meter.
- Install the meter vertically or horizontally between two gate valves so that the arrow on the body matches the flow direction. Please note the following installation examples.
- Install the temperature sensors in the same circuit as the meter.
- Seal temperature sensors and screw connections to prevent manipulation.
- Remove the rubber band from the volume measuring part. During operation, the temperature sensor cable and control line should not be in direct contact with the volume measuring part.
- If you install the meter as a cooling meter, follow the corresponding instructions.

Recommendation: If you install several meters, the same installation conditions should apply to all meters.

Changing the installation location

Note: The installation location can be changed in the field if this function has been enabled at the factory. This function locks after 5 changes and can then no longer be used. The entries can be checked via the LCD loop "LE".

Note: Alternatively, you can change the installation location using UltraAssist.









Note: If the

POS
0.6 LP

symbol is not displayed, this function is not available.

For meters with an adjustable installation location, the installation location can be determined manually. Proceed as follows:

- Press and hold the Service button (for more than 3 seconds) until "Para" appears on the LCD.
- Press button 2 briefly until  appears on the LCD.
- Press button 1 briefly several times until  appears on the LCD.
- Briefly press button 2 to display the current installation location. Depending on the installation location,  or  is displayed.
- To change the installation location, press button 1. The display changes.
- Press button 2 briefly until "*" appears on the LCD.
- To complete the parameterization, briefly press button 1 several times until  appears on the LCD.
- Press button 2 briefly to complete the change.
- The change can be checked using the symbols ( or ) on the LCD.
- If necessary, adjust the temperature sensors according to the installation requirements.

Installation recommendations

- During installation, make sure that water cannot enter into the calculator during operation.
- Inlet or outlet sections are not necessary but are recommended.
- If you install the meter in the common return of two circuits, select an installation location with a minimum distance of 10 × DN from the T-piece.
- The temperature sensor ends should reach at least into the middle of the pipe cross-section.

Examples of integration

Ball valve

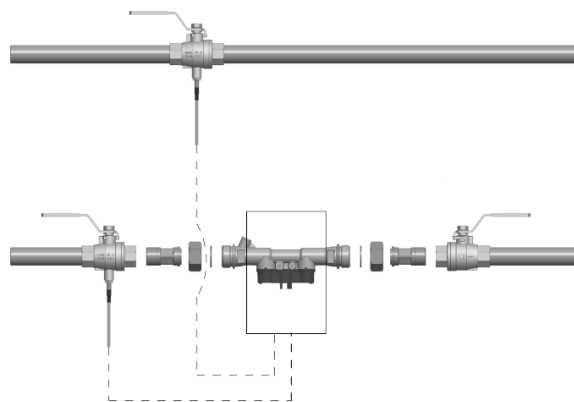

Fig. 7: Installation with ball valve (recommended up to and including DN25)

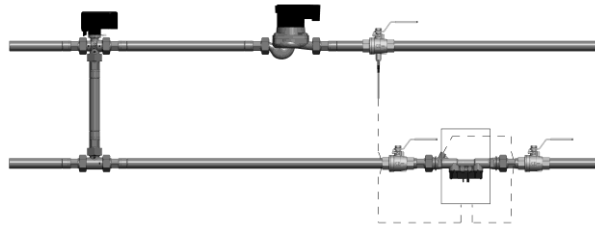

Fig. 8: Installation for circulation with admixture; placement of temperature sensors

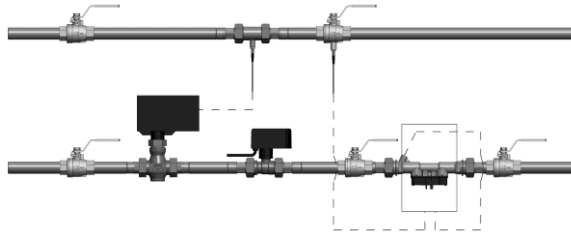

Fig. 9: Installation for circulation with throttle circuit, for example (flow sensor in flow direction before control valve / differential pressure regulator)

Installation instructions for the adapter set (direct immersion temperature sensor)

An installation set is included for meters with a $\text{Ø } 5.2 \times 45 \text{ mm}$ temperature sensor. This allows you to immerse the temperature sensor directly in an installation piece or a ball valve, for example.

1. Install the O-ring into the installation point using the enclosed mounting aid/pin.
2. Place both halves of the plastic fitting around the 3 recesses on the temperature sensor.
3. Press the screw connection together and screw the screw connection into the installation point as far as it will go (tightening torque 3 ... 5 Nm).

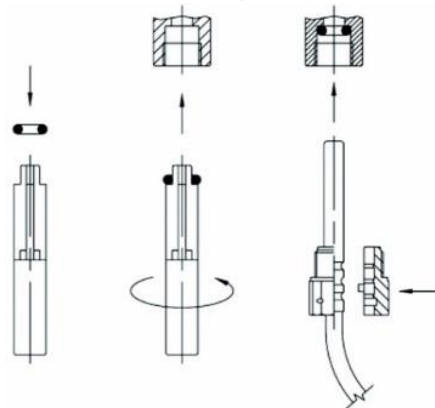

Fig. 10: Mounting adapter set

Torques

Please note the following torques for tightening the screws and nuts on the meter:

- Screw on the device cover (Fig.1, No. 4): min. 1 Nm
- All other screws: Hand-tightened to approx. 0.5 Nm

Installation for cooling meters and combined heat/cooling meters

To prevent condensation from forming, observe the following installation instructions:

- Install the cooling meter so that the black cover on the measuring tube faces to the side or downwards.

- Install the calculator separately from the volume measuring part, e.g. on the wall.
- Create a downwards loop with the connected lines.
- Install the thermowells in such a way that the temperature sensors are horizontal or vertical.

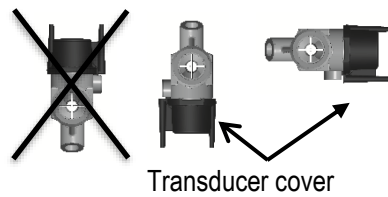

Fig. 11: Recommended installation position of cooling meters and combined heat/cooling meters

Protection class

The protection class of the calculator and the volume measurement unit is indicated on the calculator dial plate, e. g. IP54/68. The first specification (IP54 in the example) refers to the protection class of the calculator and the second specification (IP68 in the example) to the protection class of the volume measuring unit.

6 Operating elements

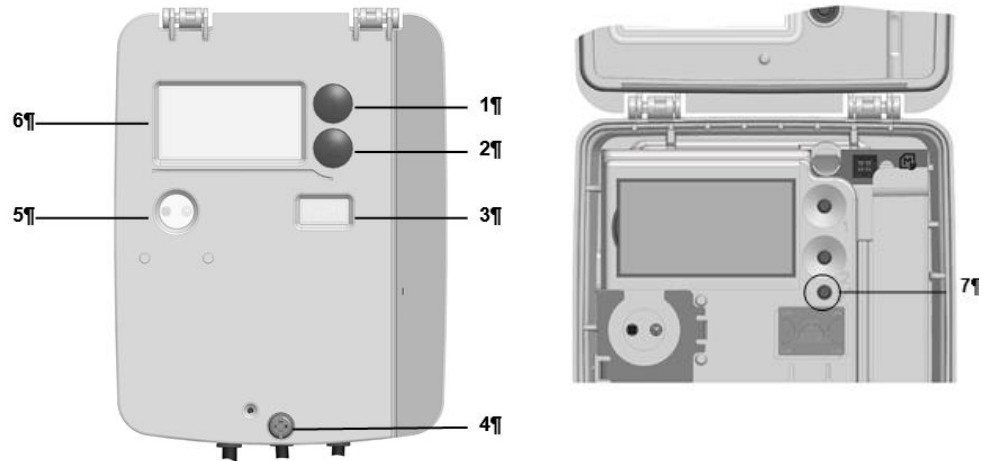





Fig. 12: Operating elements

No.	Name	Description	Note
1	Button 1	Switches to the next display value within a loop.	
2	Button 2	Switches to the next loop.	
3	Security seal		
4	Screw		
5	Optical interface	Permits data communication via a computer with the necessary service software.	
6	LCD		
7	Service button	To call up the parametrization operation of the meter.	Accessible after removing the cover.

6.1 Displaying current meter status

The meter displays the current meter status in kWh, MWh, MJ or GJ.

- 
Note: To avoid reading errors, the decimal places of displayed values are marked by a frame.
- 
Note: Calibrated values can be recognized by an additionally displayed star symbol (S12).
- 
Note: Depending on the device parameterization, both the display scope and the displayed data may deviate from this description.

LCD

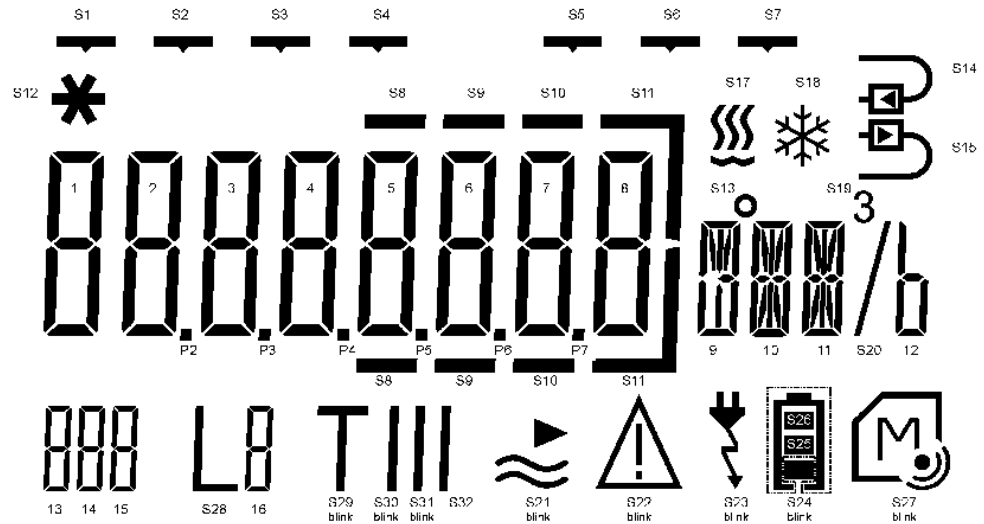

Fig. 12: LCD

ID-No.	Sym- bol	Description
S1		Hourly value
S2		Daily value
S3		Monthly value
S4		Yearly value
S5		Maximum value
S6		Minimum value
S7		Average
S8–S11		Decimal places
S12		Calibrated value
S14		Place of installation, return
S15		Place of installation, flow
S17		Meter type: Heat meter or combined heat/cooling meter
S18		Meter type: Cooling meter
S21		Current flow rate
S22		Error message
S23		Power supply: Mains
S24–S26		Power supply: Battery with capacity indicator
S27		Module identifier
S28		Current loop display (LOOP)
S29–S32		Tariff display
S13 – 15		Current display code (LCD-ID)

LOOP 0 "LOOP 0"

The LCD indicates the following values consecutively:



Loop head



Error message (here: currently no error)



Current energy quantity (here: kWh; heat meter; installation location: Return flow; tariff on)



Current volume



Current value tariff register 1 (only if tariff was selected)



Current value tariff register 2 (only if tariff was selected)



Current value tariff register 3 (only if tariff was selected)

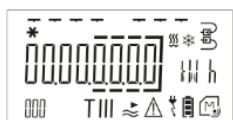

Segment test



Firmware version



CRC / CMAC

6.2 Previous year values

The meter saves the following values on the yearly set day for 16 years:

- Previous year minimum temperature hot side
- Previous year minimum temperature cold side
- Previous year maximum flow rate
- Previous year maximum power
- Previous year maximum temperature hot side
- Previous year maximum temperature cold side
- Previous year maximum temperature difference
- Previous year value energy
- Previous year value volume
- Previous year value tariff register 1
- Previous year value tariff register 2
- Previous year value tariff register 3
- Previous year value volume pulse input 1
- Previous year value volume pulse input 2
- Previous year value error time
- Previous year value flow time
- Previous year value energy (incorrect installation)
- Previous year value volume (incorrect installation)
- Yearly set date

6.3 Monthly values

The meter saves the following values on the monthly set day for up to 24 months:

- Previous month minimum temperature hot side
- Previous month minimum temperature cold side
- Previous month maximum flow rate
- Previous month maximum power
- Previous month maximum temperature hot side
- Previous month maximum temperature cold side
- Previous month maximum temperature difference
- Previous month value energy
- Previous month value tariff register 1
- Previous month value tariff register 2
- Previous month value tariff register 3
- Previous month value volume pulse input 1
- Previous month value volume pulse input 2
- Previous month value error time
- Previous month value flow time
- Previous month value energy (incorrect installation)
- Previous month value volume (incorrect installation)
- Monthly set date

6.4 Mid-month values

The meter saves the following values on the mid-month set day for 24 months:

- Mid-month value energy
 - Mid-month value volume
 - Mid-month value tariff register 1
 - Mid-month value tariff register 2
 - Mid-month value tariff register 3
 - Mid-month value volume pulse input 1
 - Mid-month value volume pulse input 2
 - Mid-month set date
-

7 Display / priority rating



Note: The number of places after the decimal point of a value is based on the nominal flow rate and the chosen dimension.



Note: The number of decimal places of a value can be adjusted in accordance with the normative requirements.

The following selectable standard display resolution are used for the energy:

Nominal flow [m ³ /h]	Energy [kWh]	Energy [MWh]	Energy [MJ]	Energy [GJ]	Energy [MBtu]	Energy [Gcal]
0.6	00000001	00000.001	00000001	00000.001	00000001	00000.001
1.5	00000001	00000.001	00000001	00000.001	00000001	00000.001
2.5	00000001	00000.001	00000001	00000.001	00000001	00000.001
3.5	00000001	00000.001	00000001	00000.001	00000001	00000.001
6	00000001	00000.001	00000001	00000.001	00000001	00000.001

The following selectable standard display resolution are used for the volume:

Nominal flow [m ³ /h]	Volume [m ³]	Volume [gal]
0.6	000000.01	00000001
1.5	000000.01	00000001
2.5	000000.01	00000001
3.5	000000.01	00000001
6	000000.01	00000001

8 Power supply



Note: The lifetime of battery depends on the type of battery and on the requirements.



Note: When replacing the battery, ensure that the battery service life is longer than the planned life cycle of the meter.



Note: Only batteries approved by the manufacturer may be installed.

The meter is powered by battery or additionally by the M-Bus module.

Options:

- 6 years battery
- 11 years battery
- 16 years battery
- 20 years battery

Power supply requirements

	6 years	11 years	16 years	20 years
Standard meter *	1xAA	2xAA	3xAA	4xAA
Radio module 868 MHz (mobile radio 30 sec. transmission interval)	2xAA	3xAA	4xAA	-

* The battery life of a standard meter was calculated basing on the following assumptions:

- Observance of the given restrictions in terms of environmental conditions
- Temperature of the calculator annually averages 35 °C
- Heating period ½ year
- Measuring interval of the flow rate every 2 sec.
- Adaptively measurement of temperature within an interval of 4-32 sec.
- LCD power saving mode
- 2 pulse inputs with 50 % Duty Cycle max. 2 Hz
- 1 monthly readout via the optical interface

Dynamical calculation of battery life



Note: Note that after the replacement of the battery a parametrization of the number of batteries via UltraAssist is required in order to ensure a faultless calculation of the battery life.



Note: Alternatively, the date (month, year) of the battery change can be transmitted via M-Bus and radio.

The dynamic battery life calculation estimates the expected remaining battery life.

The calculation is based on the consumption and parametrization of the meter. In case that the parametrization is changed the adjustment automatically affects the prospective battery life. If the meter detects a higher or lower energy consumption than previously estimated, it autonomously increases or reduces the value of battery life displayed. The value of battery life is indicated by a battery icon on the LCD additionally provided with a date (month, year).

9 Communication

Electronic unit interfaces

The calculator is equipped with an optical interface in accordance with EN 62056-21:2002 and two water meter pulse inputs as standard.

You can also use one of the following communication modules for remote reading:

- Pulse module
- M-Bus-module
- Radio module

These modules do not have an effect on the measurement. You can retrofit the modules at any time without damaging the security seal.



Note: You will find the technical details and data on communication modules in their respective documentation.

Terminals

2-pole or 4-pole terminals are used for connection of the external cables to the modules.

- Stripping length 6 mm
- Connection capacity
 - rigid or flexible, 0.14 ... 1.5 mm²
 - flexible with wire and ferrule, 0.25 ... 1.5 mm²
 - flexible with wire end ferrule without plastic sleeve, 0.25 ... 1.0 mm²
 - conductor sizes 26 ... 14 AWG
- Recommended screwdriver:
 - 0.6 × 3.5 mm
- Tightening torque: 0.35 ... 0.4 Nm

9.1 Pulse output module



Note: The output mode as well as standard or high-resolution pulses can be parameterized via UltraAssist.

The pulse output module T45-PULSE enables the output of pulses on 2 configurable channels.

On channel 1 (terminal 16, 17):

- energy (CE)
- volume (CV) or
- tariff register 1 (C1)

pulses can be output.

On channel 2 (terminal 18, 19):

- volume (CV)
- tariff register 1 (C1) or
- tariff register 2 (C2)

pulses can be output.

The pulse duration is identical on both channels.

Type	Open drain
Classification	OB / OC (according EN 1434-2)
Voltage	max. 30 V
Current	max. 30 mA
Dielectric strength	500 V _{eff} against ground
Voltage drop	0.9 V at 30 mA (OB) / 0.1 V at 0.1 mA (OC)

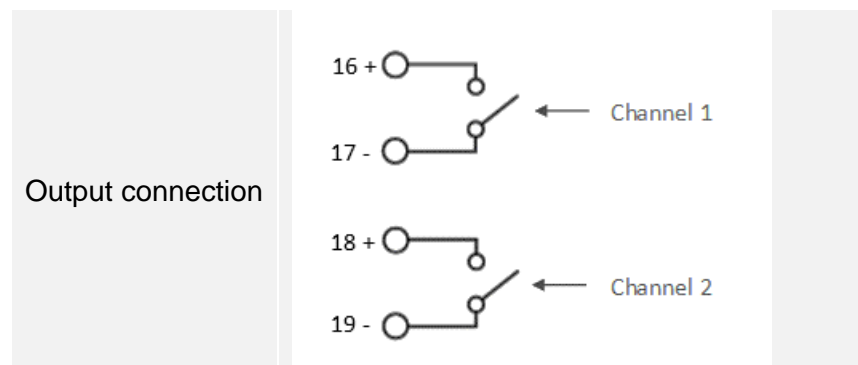

9.2 M-Bus module



Note: The data scope of the readout can be parametrized via UltraAssist.

The M-Bus module is used to communicate the meter with an M-Bus central unit for the wireless transmission of measured values.

All meter data can also be read out via the M-Bus interface.

Standard	EN 13757-2
Conformity	OMS
Separation/Connection	Galvanically coupled
Power consumption	Max. 1 M-Bus load (1.5 mA)

Addressing meter	Primary or secondary
Addressing pulse inputs	Primary or secondary
Readout frequency	300 Bd and 2400 Bd with automatic baud rate detection

9.3 Radio Module 868 MHz (Wireless M-Bus)

The wireless M-Bus function enables the meter to communicate with a stationary unit or a mobile unit using 868 MHz radio frequency.

The module supports the OMS¹-compliant data transfer including an individual encryption function.

General notes	
Standard	Open Metering System Specification Vol.2 Issue 4.1.2: 2016 EN 13757-3:2018; EN 13757-4:2019
Radio mode	T1 or C1
Sending frequency with T1 / C1	868.95 MHz (min. 868,928 MHz up to max. 868.972 MHz)
Transmission power (ERPg)	Min. 3.16 mW (5 dBm) to max. 25 mW (13.9 dBm)
Sending interval	6 sec. – 24 h configurable
Encryption	Without, safety profile A (encryption mode 5) or safety profile B (encryption mode 7)
Range	
Free field	Up to max. 400 m
Within building	E. g. horizontal 30 Meter
Power supply	

Via meter 1 – 4 battery type AA

Battery life

Radio mobile (30 sec.) 16 years life span**)

Radio stationary (15 min.) 20 years life span**)

- 1) Open Metering System
- *) May vary depending on terrain and building structure.
- ***) Meter in standard configuration, data telegram F000 respectively F001, T1, frame format A, encryption mode 7, 4x AA cells.

10 Pulse inputs



Note: The pulse inputs need to be activated via UltraAssist.



Note: It is recommended to use the pulse input set T45-PULSE-IN for the connection.

The meter has 2 pulse inputs enabling the determination in number of external volume pulses which can be generated, for example, by a cold water meter and / or a hot water meter.

The pulse inputs can be output via the 868 MHz radio module, the M-Bus module or the optical interface.

The meter readings of the pulse inputs are also indicated on the LCD.

Standard	Class IB / IC according to EN 1434-2
Max. cable length	10 m
External connection	Open Drain Pulse input 1: signal on terminal 65, mass on terminal 66 Pulse input 2: signal on terminal 67, mass on terminal 68
Max. power	Max. 3 µA
Maximal pulse frequency	2 Hz

Minimal pulse length Min. 30 ms

Polarity Active low

11 Tariff control (optional)



Note: The tariffs can only be parameterized using the service software.



Note: The summation of quantity of energy and volume in the standard registers is performed independently of the tariff situation.

The following options are available for tariff control:

Threshold value tariff (tariff T1 - T5, T9 – T13)

The thresholds S1, S2 and S3 can be derived from:

- flow rate (tariff T1, T9),
- power (tariff T2, T10),
- temperature cold side (tariff T3, T11),
- temperature hot side (tariff T4, T12) or
- temperature difference (tariff T5, T13)

For the tariffs T1 - T5, the energy is added to the tariff registers while for the tariffs T9 - T13 the same is done for the volume.

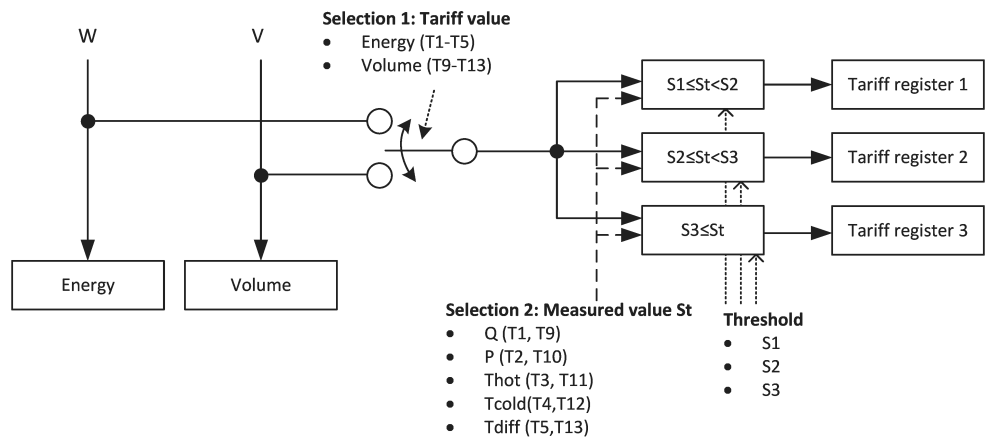

Fig. 14: Threshold value tariffs

Summation in the relevant tariff register is only performed if the relevant threshold is exceeded.

- Threshold 1 exceeded: Summation in tariff register 1
- Threshold 1 and 2 exceeded: Summation in tariff register 2
- Threshold 1, 2 and 3 exceeded: Summation in tariff register 3

Supplied quantity of energy (tariff T6)

In tariff register 1, the energy is summated up, which is calculated from the temperature hot side and the reference temperature.

Returned quantity of energy (tariff T6)

In tariff register 1, the energy is summated up, which is calculated from the temperature cold side and the reference temperature.

Heat / cooling meter (tariff T7)

In tariff register 1, the measured quantity of cold; in tariff register 2, the measured quantity of heat is summated. In both cases a threshold can be defined via the temperature hot side ("cold threshold", "heat threshold").

- Temperature above "heat threshold" and temperature difference $> +0.2$ K → quantity of heat is acquired
- Temperature below "cold threshold" and temperature difference < -0.2 K → quantity of cold is acquired

Surcharge quantity tariff by means of return temperature (tariff T8)

The quantity of energy is summated depending on the temperature cold side in tariff registers 1 or 2.

The summated quantity of energy is calculated from the difference of the temperature cold side from the defined return temperature threshold (instead of from the temperature difference).











- Above return threshold: T1 is summated
- Below return threshold: T2 is summated

Volume-weighted temperature (Tarif T14)

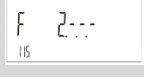
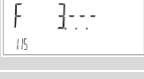
The result of multiplying the volume by the temperature of the warm side is added to tariff register 1. The result of multiplying the volume by the temperature of the cold side is added to tariff register 2.

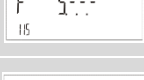
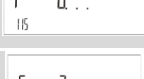
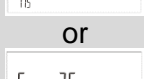
12 Error messages

The meter continuously runs a self-diagnosis and can thus recognize and display various installation or meter error messages.

Error code	Error	Service guidelines
	Wrong flow direction	Check flow and installation direction; correct if necessary
if necessary in exchange with:		
	Negative temperature difference	Check installation position of temperature sensor; exchange if necessary
if necessary in exchange with:		
	No flow measurable	Air in the measurement unit/pipe; bleed the line (status of delivery)
	Temperature sensor warm side interruption	Check hot side of temperature sensor, replace if necessary
	Temperature sensor cold side interruption	Check temperature sensor cold side, replace if necessary
	PCB for temperature evaluation defective	Change the meter
	Battery empty; power supply problem	Replace battery; check connection
	Short-circuit temperature sensor hot side	Check hot side of temperature sensor, replace if necessary
	Short-circuit temperature sensor cold side	Check temperature sensor cold side, replace if necessary
 or 	Error in internal memory	Change the meter. The measurements of the meter may no longer be used for legally calibrated billing.
	F1, F2, F3, F5 or F6 persisting for more than 8 hours, attempted Manipulation detected (here: F1 longer than 8 hours).	The action depends on the error code. This F8 error message must be reset by the Service Department.
	Error in the PCB	Change the meter



Note: Reset the message F8 in the parameterization mode manually or with UltraAssist. All other error messages are automatically deleted after the error has been corrected.

13 Log functions



Note: Read-out is performed via M-Bus or the optical interface with UltraAssist.

In the internal logbook, metrologically relevant events (errors, states, actions) are stored in chronological order with their time of occurrence. The events acquired are predefined. The data of the logbook cannot be deleted.

Each event is stored in a separate 4-level shift register; the overflows are transferred to a 25-level circulating buffer. Therefore, at least the last 4 times can be traced for each event.

In a monthly register, the error states are stored for the current month and for the past 18 months (without time stamp).

Description

F0 = Flow measurement not possible

F1 = Interruption hot side temperature sensor

F2 = Interruption cold side temperature sensor

F3 = Electronics for temperature evaluation defective

F4 = Battery status critical

F5 = Short circuit hot side temperature sensor

F6 = Short circuit cold side temperature sensor

F7 = Data storage defective

F8 = Temperature sensor error > 8 hours

F9 = Internal communication error

F10 = CRC incoherent

F11 = Flow sensor mounted incorrectly

F12 = Temperature sensors mounted incorrectly

W0 = Soiling prewarning

W1 = Storage prewarning

W2 = Voltage drop during COM

W3 = Battery must be replaced

W4 = Pipe burst detected

W5 = Leakage detected

E0 = Mains operation

E1 = Temperature in the flow sensor above 130° C

E2 = Temperature in the flow sensor below 5° C

E3 = Maximum flow rate (qs) exceeded

E4 = Temperature in the calculator above 55° C

E5 = Temperature in the calculator below 5° C

E6 = Reset

E7 = Negative flow

E8 = Negative temperature difference

E9 = Bubbles detected in the flow

E10 = Commissioning

P0 = Calibration seal set

P1 = Reset of max / min / average values

P2 = Reset of time counters

P3 = Reset of tariff registers

P4 = Reset of datalogger

P5 = Calibration values parameterized

P6 = Meter time / date set

P7 = Set day parameterization

P8 = Master reset

P9 = LCD parameterization

P10 = Tariff parameterization

P11 = Leakage detection parameterization

P12 = Datalogger parameterization

P13 = Pulse input parameterization

P14 = Pulse output parameterization

P15 = M-Bus parameterization

P16 = wM-Bus parameterization

14 Datalogger (optional)

The data logger allows archiving of data individually selected from a predefined set of values. The data logger contains four archives, to which 4 channels can be assigned.

Archive	Memory depth	Default setting
Hour archive	48-1842 hours *)	1472 hours
Day archive	30-1824 days *)	400 days
Month archive	60 months	60 months
Year Archive	20 years	20 years

*) The memory depth of the hour- and day archives can be changed, in total both archives together must have 1872 entries.



Note: Parameterization and readout is performed via the optical interface with the service software.



Note: The values of the data logger are only output on the optical interface.

	Values
Meter readings at the end of the period for...	Energy *) Volume *) Tariff register 1 Tariff register 2 Tariff register 3 Volume Pulse input 1 Volume pulse input 2 Missing time Flow time Energy Faulty installation Volume incorrect installation Error flags

Current values at the end of the period for...	Power Flow rate Temperature hot side Temperature cold side Temperature difference Device temperature
Minimum values for...	Temperature warm side Temperature cold side
Maximum values for...	Power Flow rate Temperature hot side Temperature cold side Temperature difference
Average values for...	Power *) Flow rate *) Temperature hot side Temperature cold side

*) Default value in the archives.

15 Order codes (type number key)

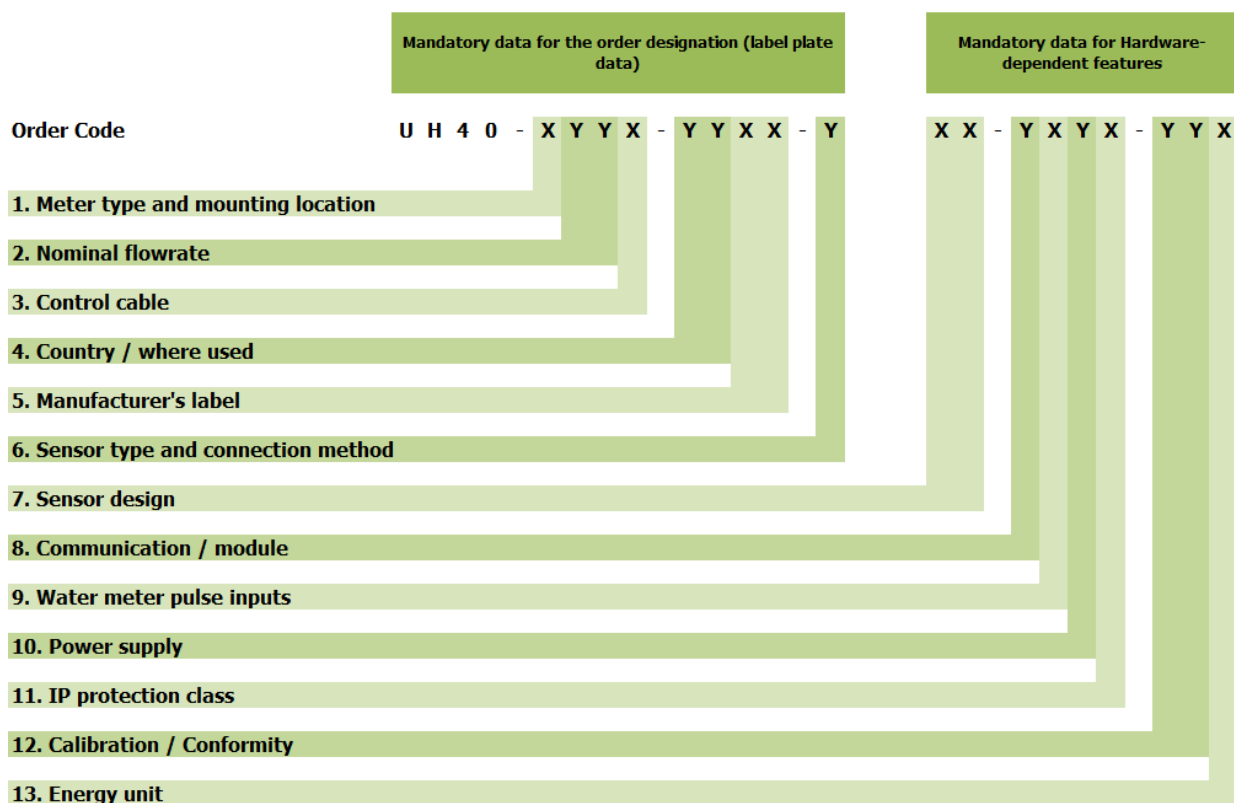

Order codes for label plate data	
1. Type of meter and mounting location	Code
Heat meter; mounting place cold side	A
Heat meter; mounting place hot side	B
Combined heat/cooling meter, mounting place cold side	C
Combined heat/cooling meter, mounting place hot side	E
Cooling meter; mounting place hot side	G
Cooling meter; mounting place cold side	H
2. Nominal flowrate	Code
Nominal flowrate 0.6 m³/h, length 110 mm, nominal pressure PN16, connection G ¾ B	05
Nominal flowrate 0.6 m³/h, length 110 mm, nominal pressure PN25, connection G ¾ B	06
Nominal flowrate 0.6 m³/h, length 190 mm, nominal pressure PN16, connection G 1 B	07
Nominal flowrate 0.6 m³/h, length 190 mm, nominal pressure PN25, connection G 1 B	09

Nominal flowrate 1.5 m³/h, length 110 mm, nominal pressure PN16, connection G ¾ B	21
Nominal flowrate 1.5 m³/h, length 110 mm, nominal pressure PN25, connection G ¾ B	22
Nominal flowrate 1.5 m³/h, length 190 mm, nominal pressure PN16, connection G 1 B	23
Nominal flowrate 1.5 m³/h, length 190 mm, nominal pressure PN25, connection G 1 B	25
Nominal flowrate 1.5 m³/h, length 130 mm, nominal pressure PN16, connection G 1	26
Nominal flowrate 1.5 m³/h, length 130 mm, nominal pressure PN25, connection G 1	27
Nominal flowrate 2.5 m³/h, length 130 mm, nominal pressure PN16, connection G 1 B	36
Nominal flowrate 2.5 m³/h, length 130 mm, nominal pressure PN25, connection G 1 B	37
Nominal flowrate 2.5 m³/h, length 190 mm, nominal pressure PN16, connection G 1 B	38
Nominal flowrate 2.5 m³/h, length 190 mm, nominal pressure PN25, connection G 1 B	40
Nominal flowrate 3.5 m³/h, length 260 mm, nominal pressure PN16, connection G 1¼ B	43
Nominal flowrate 3.5 m³/h, length 260 mm, nominal pressure PN25, connection G 1¼ B	44
Nominal flowrate 6 m³/h, length 260 mm, nominal pressure PN16, connection G 1¼ B	53

Nominal flowrate 6 m ³ /h, length 260 mm, nominal pressure PN25, connection G 1¼ B	54
3. Control cable	Code
Split version with 1.5 m control cable	C
Split version with 5.0 m control cable	E
4. Country / where used	Code
Dial plate for Germany (German)	DE
Dial plate English neutral	EN
5. Manufacturer's label	Code
Logo Landis+Gyr	00
Other labels on request	XX
6. Sensor type and method of connection	Code
Sensor Pt100, removable, not mounted in the tube	A
Sensor Pt500, removable, not mounted in the tube	E
Sensor Pt500, removable, mounted in the tube	F
Sensor Pt500, not removable, not mounted in the tube	N
Sensor Pt500, not removable, mounted in the tube	P
Hardware-dependent features	
7. Sensor type	Code
Without sensors	00
Type DS, 25 bar/150 °C/ M10x1 / immersion length 27.5 mm, cable length 1.5 m	0B
Type DS, 25 bar/150 °C/ M10x1 / immersion length 27.5 mm, cable length 2.5 m	0C
Type PL, 25 bar/150 °C/ Ø5x45 mm, cable length 1.5 m	0F
Type PL, 25 bar/150 °C/ Ø5x45 mm, cable length 5 m	0G
Type PS, 16 bar/150 °C/ Ø5.2x45 mm, cable length 1.5 m	0H
Type PS, 16 bar/150 °C/ Ø5.2x45 mm, cable length 5 m	0J
Type DS, 25 bar/150 °C/ M10x1 / immersion length 38 mm, cable length 1.5 m	0D

Type DS, 25 bar/150 °C/ M10x1 / immersion length 38 mm, cable length 2.5 m	0E
8. Communication	Code
No module	0
Pulse module	P
M-Bus module	B
Radio module 868 MHz, stationary	E
Radio module 868 MHz, external antenna	F
9. Water meter pulse inputs	Code
Without water meter pulse inputs	0
With water meter pulse inputs	1
10. Power supply	Code
Battery for 6 years	A
Battery for 11 years	B
Battery for 16 years	C
Battery for 20 years	D
11. IP protection class	Code
Calculator IP54 / volume measurement unit IP54 (only for heating meters and combined heating- / cooling meters)	A
Calculator IP54 / volume measurement unit IP65 (only for cooling meters)	B
Calculator IP54 / volume measurement unit IP68	C
Calculator IP68 / volume measuring part IP68	D
12. Calibration / conformity	Code
Compliant acc. to national regulations	TL
Certified acc. to national regulations	CL
Compliant to MID class 2	M2
Compliant to MID, class 3	M3
Compliant with CEN 1434, class 2	T2
Compliant with CEN 1434, class 3	T3

13. Energy unit	Code
Display: kWh	A
Display: MWh	B
Display: MJ	C

Display: GJ	D
Display: MBTU	E
Display: Gcal	F

16 Additional order details

16.1 Additional order details for the data logger

Example for data logger:

UH40-XXXX-YY00-X YY-XYXY-YYX + **DL**

16.2 Additional order details for the wM-Bus function

T450 (UH40) meters are parameterized ex works with settings for operating a wM-Bus module. This happens regardless of the configuration of the meter, i.e. even if no wM-Bus module is installed in the meter. If no detailed information on the required radio parameters was given when ordering, the settings summarized as F000 are parameterized. Other settings can be ordered by specifying other parameter Ids (FXXX).

1. Example for radio standard stationary (F000; default):

UH40-XXXX-YY00-X YY-**EXYX**-YYX + **F000**

E = Radio module 868 MHz mounted ex works

F000 summarizes the following parameters:

Radio Standard Stationary		Data Telegram	
Radio Mode	T1	Current energy	
Encryption	None	Current volume	
Usable Bytes	42	Current flow	
Transmission Interval [s]	900	Current power	
Energy Unit	kWh	Current temperature hot side	
Battery life	6, 11, 16 a	Current temperature cold side	
		Error flags	
		Meter time	

2. Example for radio standard mobile (F001):UH40-XYXX-YY00-X YY-EXYX-YYX + **F001**

E = Radio module 868 MHz mounted ex works

F001 summarizes the following parameters:

Radio Standard Mobile	
Radio Mode	T1
Encryption	None
Usable Bytes	56
Transmission Interval [s]	30
Energy Unit	kWh
Battery life	6, 11, 16 a

Data Telegram
Current energy
Current volume
Prev. month value energy (1)
Prev. month value volume (1)
Prev. month storage day (1)
Prev. year value energy (1)
Prev. year storage day (1)
Error flags
Meter time

3. Example for standard radio combined meters (F003):UH40-XYXX-YY00-X YY-EXYX-YYX + **F003**

E = Radio module 868 MHz mounted ex works

F003 summarizes the following parameters:

Standard Radio Combined Meters	
Radio Mode	T1
Encryption	None
Usable Bytes	50
Transmission Interval [s]	900
Energy Unit	kWh
Battery life	6, 11, 16 a

Data Telegram
Current energy
Current value tariff register 1
Current volume
Current flow
Current power
Current temperature hot side
Current temperature cold side
Error flags
Meter time

17 Pressure loss, weight, and dimension of package

Nominal flow rate q_p		0.6	0.6	1.5	1.5	1.5	2.5	2.5	[m ³ /h]
Overall length		110	190	110	130	190	130	190	[mm]
Connection		G ³ / ₄	G1	G ³ / ₄	G1	G1	G1	G1	
Maximum flow rate q_s		1.2	1.2	3	3	3	5	5	[m ³ /h]
Minimum flow rate q_i		6	6	15	15	15	25	25	[l/h]
Threshold (variable)		2.4	2.4	6	6	6	10	10	[l/h]
Pressure loss at q_p		150	150	170	160	160	175	210	[mbar]
Kv factor at Δp 1bar		1.5	1.5	3.6	3.8	3.8	6.0	5.3	[m ³ /h]
Graph in diagram		A	A	B	C	C	E	D	
Weight		0.8	1.1	0.8	0.8	1.1	0.8	1.1	[kg]
Dimension pack- age	length	226	226	226	226	226	226	226	[mm]
	width	186	186	186	186	186	186	186	[mm]
	height	117	117	117	117	117	117	117	[mm]

Nominal flow rate q_p		3.5	6.0	[m ³ /h]
Overall length		260	260	[mm]
Connection		G1 ¼	G1 ¼	
Maximum flow rate q_s		7.0	12.0	[m ³ /h]
Minimum flow rate q_i		35	60	[l/h]
Threshold (variable)		14	24	[l/h]
Pressure loss at q_p		155	230	[mbar]
Kv factor at Δp 1bar		9.0	12.8	[m ³ /h]
Graph in diagram		F	G	
Weight		2.0	2.0	[kg]
Dimension pack- age	length	399	399	[mm]
	width	239	239	[mm]
	height	258	258	[mm]

The indicated pressure loss of a flow sensor is at the nominal flowrate qp.
Using the Kv factor, which defines the flow rate at a pressure loss of 1 bar, the pressure loss at any given flow rate can be calculated:

$$\Delta p = 1 \text{ bar} \times \left(\frac{Q}{K_v} \right)^2$$

Δp = pressure loss in bar

Q = flowrate in m³/h

K_v = K_v – Factor at $\Delta p = 1$ bar

This value can also be determined using the diagram.

